















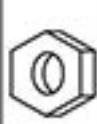

СПИСЪК НА ЧАСТИТЕ

Проверете дали всички части са налични преди сглобяването

| NO. | 1 | 2 | 3 | 4 | 5 | 6 | 7 | 8 | 9 | 10 | 11 | 12 | 13 | 14 | 15 | 16 |
|-----|--|---|---|---|---|---|---|---|---|---|--|---|---|---|---|---|
| |  |  |  |  |  |  |  |  |  |  |  |  |  |  |  |  |
| | 8PCS | 4PCS | 4PCS | 5PCS | 10PCS | 2PCS | 2PCS | 2PCS | 20PCS | 2PCS | 22PCS | 1PCS | 1PCS | 4PCS | 4PCS | 1PCS |

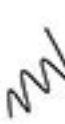
STEP 1

1. Сортирайте всички части по номера
2. Сглобете основата като затегнете болтовете само на ръка
3. Не съединявайте дългите половини на този етап

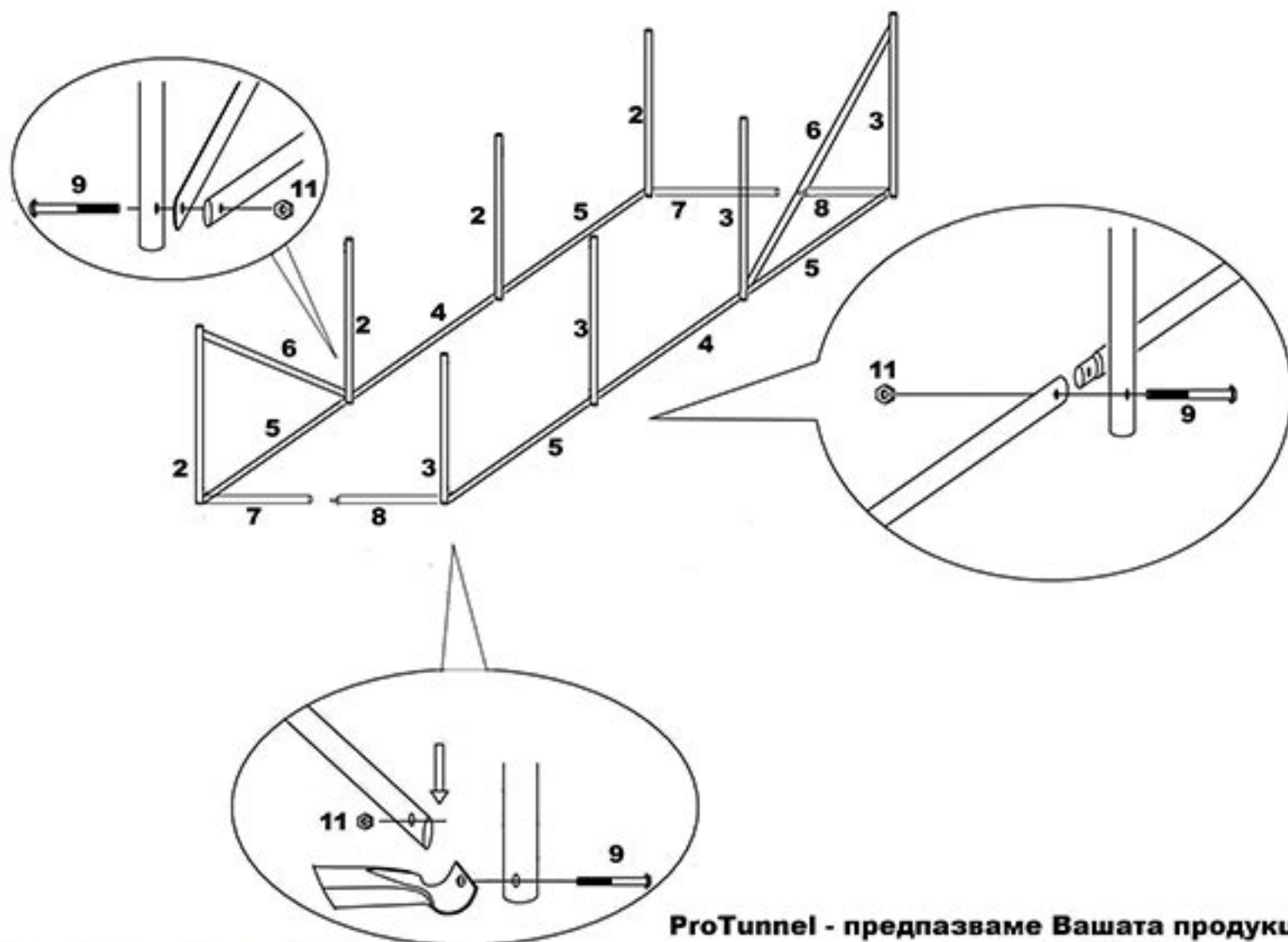

Loosely assemble complete frame,
before tightening all bolts in final position

ProTunnel - предпазваме Вашата продукция
www.sorbe.bg тел. 02 / 4744604

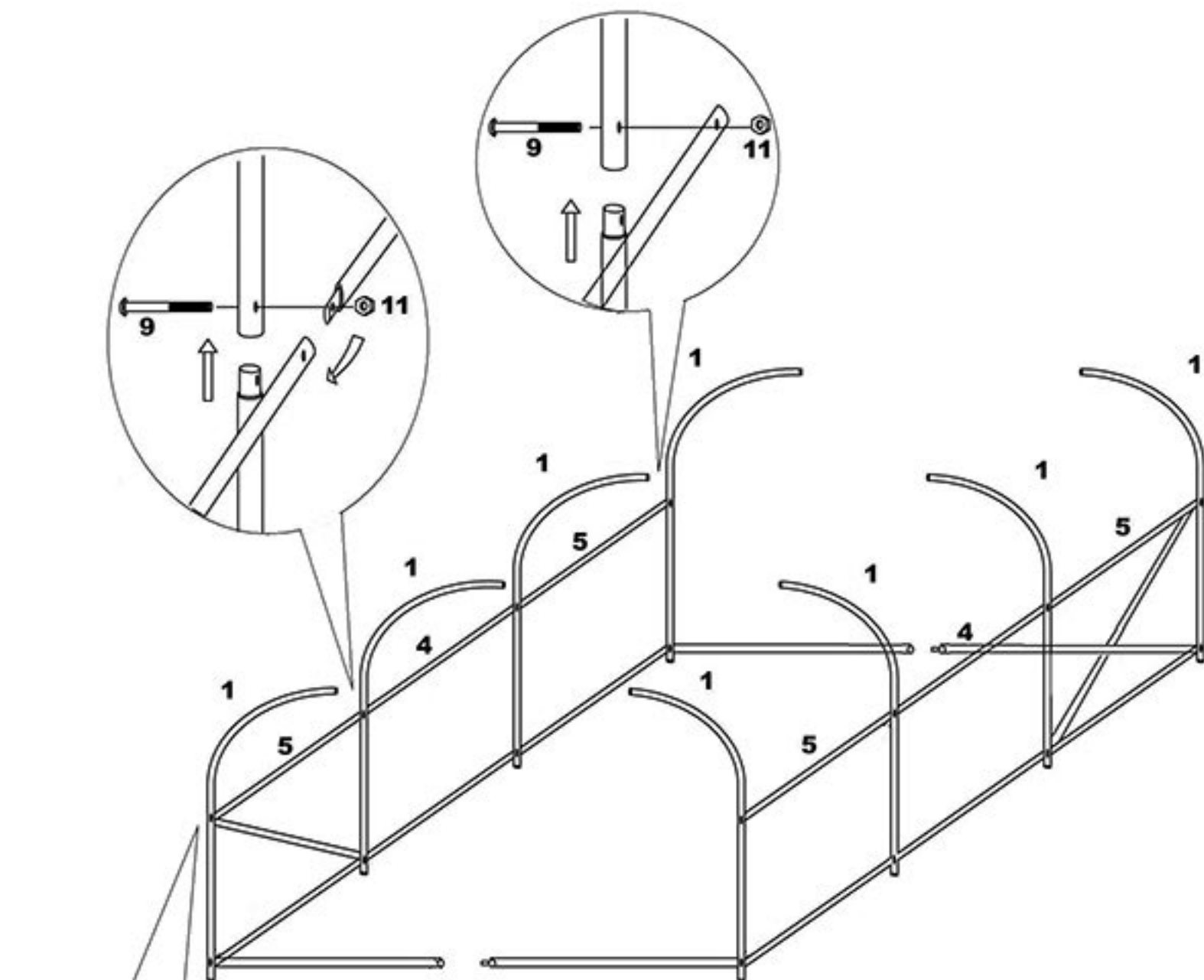

STEP 2

СТЪПКА 2

Сглобете долната част на арките и долните надлъжни усилващи тръби

Стягайте болтовете само на ръка

Loosely assemble complete frame,
before tightening all bolts in final position.

STEP 3

Съединете двете дълги половини като монтирате и горната надлъжна усилваща греда

След сглобяването затегнете всички болтове с ключ

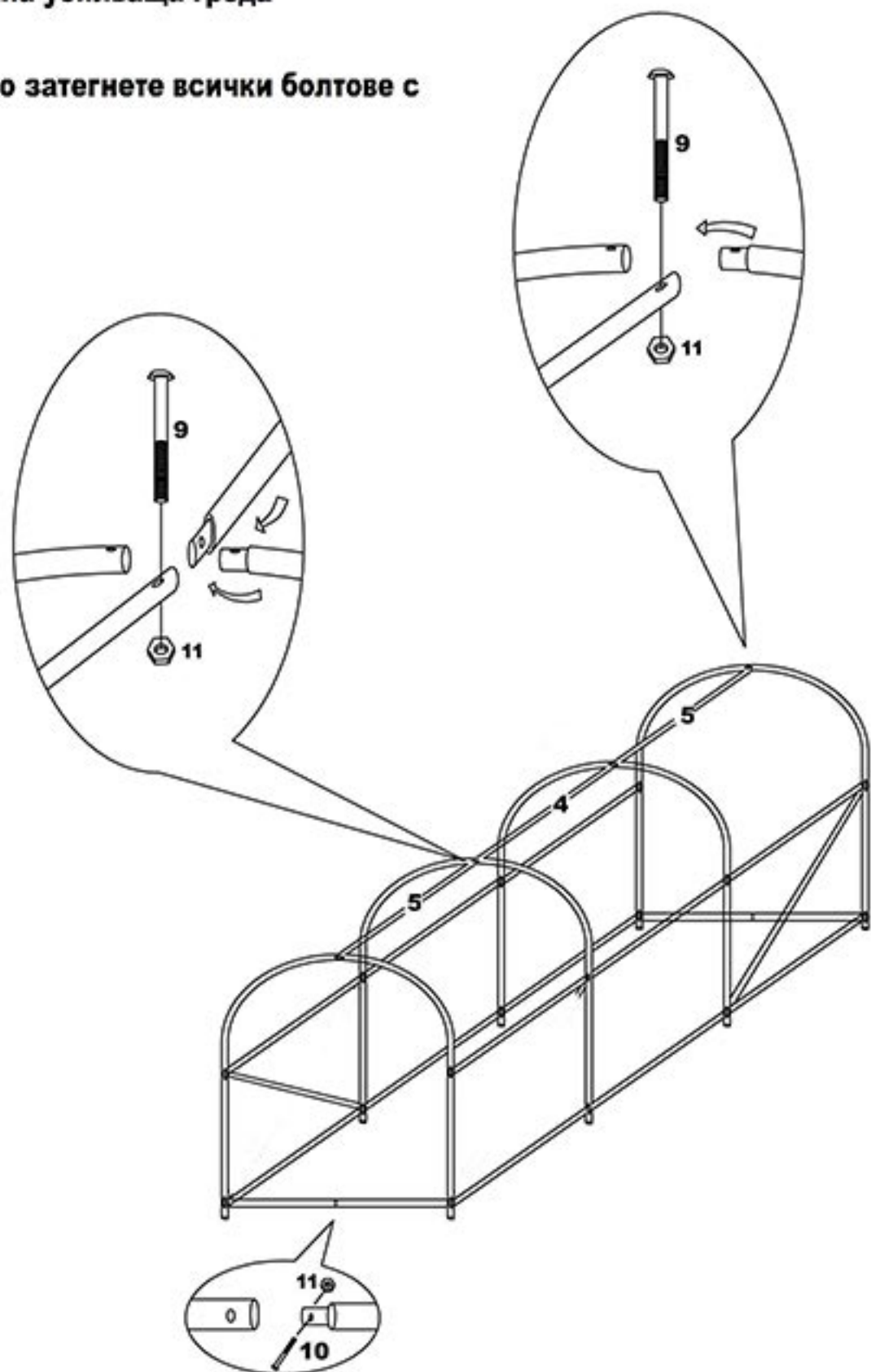

Loosely assemble complete frame,
before tightening all bolts in final position.

1. **Внимателно сложете покривалото върху конструкцията - необходими са 2-3 човека**
2. **Изкопайте плитък канал около основата на оранжерията (30 см широк)**
3. **Засипете яката на оранжерията с пръст и камъни в този канал - така ще я направите стабилна**

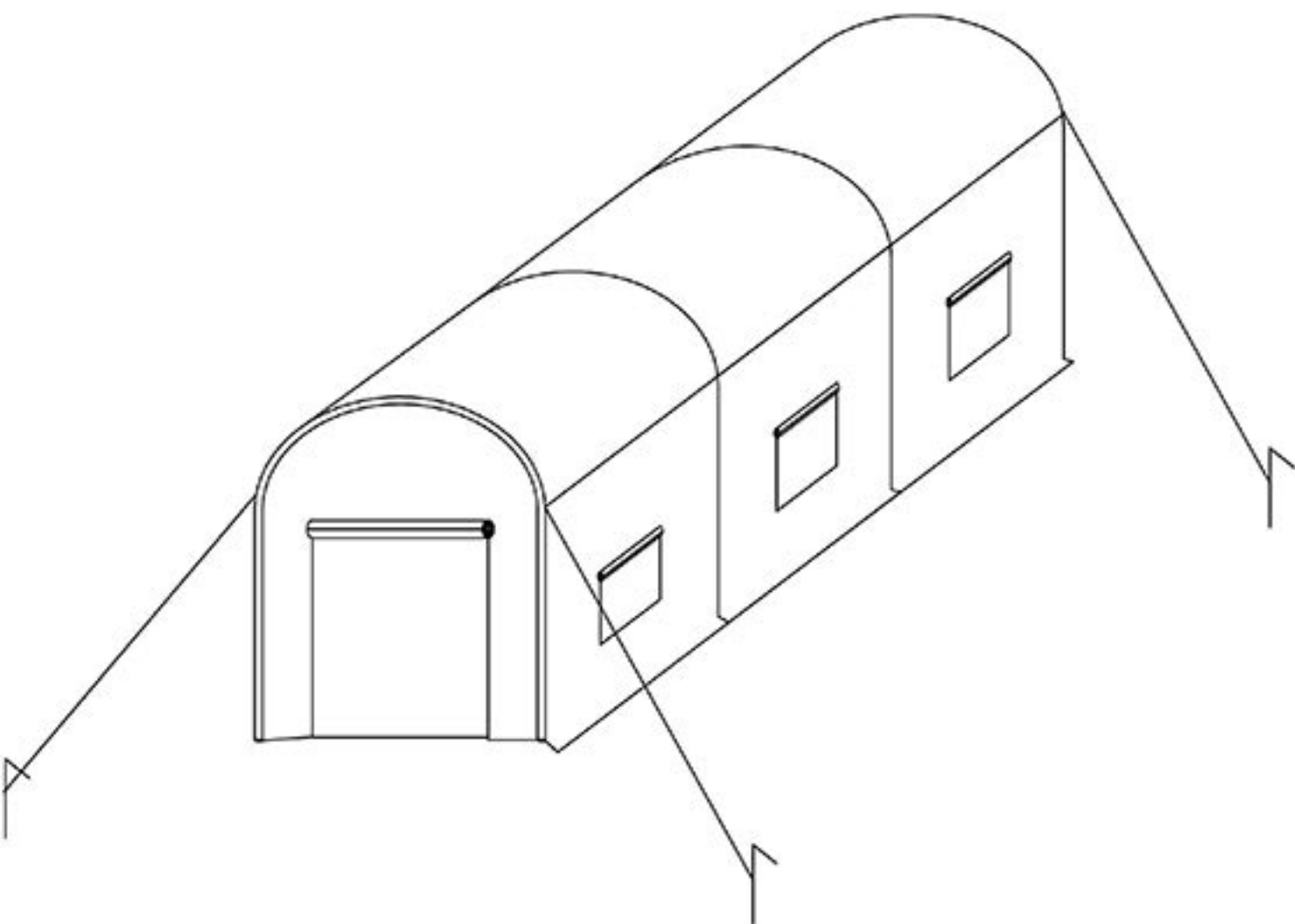

Remark:

- 1) Please carefully follow the assembly instructions.
- 2) 2-3 person assembly together .
- 3) **For Maximum stability of your polytunnel, please dig trench to bury base frame poles and back fill covering flaps of plastic canopy**